

SCAN *Me*

www.aluafric.com.eg

Km28 Cairo Alex desert road
Abu Rawash Industrial zone,
Cairo, Egypt.

For Sales : +20 114 322 8877
+20 100 7750 490
+20 111 117 6662

For Powder coating (AluPro):
+20 110 0221205
For following and suggestions:
+20 111 5051265

sales@aluafric.com.eg
info@aluafric.com.eg



SCAN *Me*



Km28 Cairo Alex desert road
Abu Rawash Industrial zone,
Cairo, Egypt.

For Sales : +20 114 322 8877
+20 100 7750 490
+20 111 117 6662

For Powder coating (AluPro):
+20 110 0221205
For following and suggestions:
+20 111 5051265

sales@aluafric.com.eg
info@aluafric.com.eg



SCAN *Me*

ABOUT STORY

ALU AFRIC FOR ALUMINIUM INDUSTRY WAS FOUNDED IN 2011 , ALU AFRIC IN THE LAST DECADE HAS POSITIONED ITSELF AS THE SPECIALIST IN EXTRUDING A WIDE ARRAY OF ALL ALUMINIUM PROFILES FOR ALL PROJECTS, SUCH AS:

- ARCHITECTURAL PROFILE
- SOLAR ENERGY PROFILE
- ILLUMINATION PROFILE
- WINDOWS PROFILE
- FURNITURE PROFILE
- RAIL INDUSTRIAL PROFILE
- AUTOMOTIVE PARTS
- DOORS PROFILE

ALU AFRIC COVERS AN AREA OF 35,000 METERS HOUSING 2 PRODUCTION BASES, WITH ANNUAL OUTPUT OF 24000 TONS

ALU AFRIC COVERS AN AREA OF 35,000 METERS HOUSING 2 PRODUCTION BASES, WITH ANNUAL OUTPUT OF 24000 TONS, IT WILL BE INCREASED BY 2022 TO BE 54000 TONS/YEARS, AND BY 2023 TO BE 90,000 TONS/YEARS.

Km28 Cairo Alex desert road
Abu Rawash Industrial zone,
Cairo, Egypt.

For Sales : +20 114 322 8877
+20 100 7750 490
+20 111 117 6662

For Powder coating (AluPro):
+20 110 0221205
For following and suggestions:
+20 111 5051265

sales@aluafric.com.eg
info@aluafric.com.eg

Standard Scaled Profiles Catalog

Flat Bar

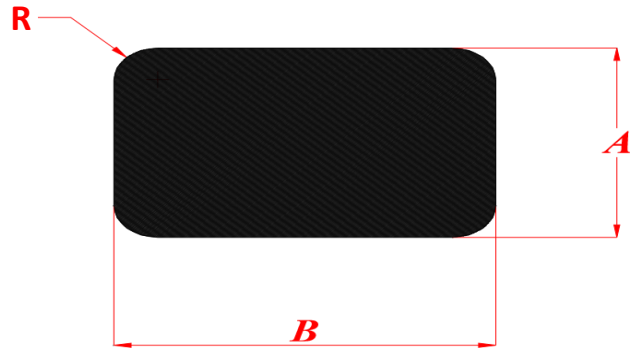

No.	B	A	R	W/m
1	15	8		0.324
2	15	10		0.405
3	19.05	3.175		0.163
4	20	3		0.162
5	20	4		0.216
6	20	5		0.27
7	20	6		0.324
8	20	8		0.432
9	20	10		0.54
10	20	12		0.648
11	20	15		0.81
12	25	3		0.203
13	25	4		0.27
14	25	5		0.338
15	25	6		0.405
16	25	8		0.54
17	25	10		0.675
18	25	12		0.81
19	25	15		1.013
20	25	20		1.35
21	25.4	12.7		0.871
22	25.4	3.175		0.218
23	25.4	9.525		0.653
24	25.4	6.35		0.435
25	30	3		0.243
26	30	4		0.324
27	30	5		0.405
28	30	6		0.486
29	30	8		0.648
30	30	10		0.81
31	30	12		0.972

Standard Scaled Profiles Catalog

Flat Bar



No.	B	A	R	W/m
32	30	15		1.215
33	30	20		1.62
34	30	25		2.025
35	31.75	25.4		2.177
36	35	3		0.284
37	35	5		0.473
38	35	6		0.567
39	35	8		0.756
40	35	10		0.945
41	35	20		1.89
42	35	25		2.363
43	38.1	3.175		0.327
44	38.1	6.35		0.653
45	38.1	4.775		0.491
46	38.1	9.525		0.98
47	38.1	19.05		1.96
48	38.1	15.875		1.633
49	38.1	25.4		2.613
50	38.1	31.75		3.266
51	40	3		0.324
52	40	4		0.432
53	40	5		0.54
54	40	6		0.648
55	40	8		0.864
56	40	10		1.08
57	40	12		1.296
58	40	15		1.62
59	40	20		2.16
60	40	25		2.7
61	40	30		3.24
62	44.45	6.35		0.762

Standard Scaled Profiles Catalog

Flat Bar



No.	B	A	R	W/m
63	44.45	19.05		2.286
64	44.45	31.75		3.81
65	44.45	15.875		1.905
66	45	5		0.608
67	50	3		0.405
68	50	4		0.54
69	50	5		0.675
70	50	6		0.81
71	50	8		1.08
72	50	10		1.35
73	50	12		1.62
74	50	15		2.025
75	50	20		2.7
76	50	25		3.375
77	50	30		4.05
78	50	35		4.725
79	50	40		5.4
80	50.8	4.76		0.653
81	50.8	9.525		1.306
82	50.8	19.05		2.613
83	50.8	25.4		3.484
84	50.8	38.1		5.226
85	50.8	6.35		0.871
86	50.8	12.7		1.742
87	50.8	3.175		0.435
88	60	3		0.486
89	60	4		0.648
90	60	5		0.81
91	60	6		0.972
92	60	8		1.296
93	60	10		1.62

Standard Scaled Profiles Catalog

Flat Bar



No.	B	A	R	W/m
94	60	12		1.944
95	60	15		2.43
96	60	20		3.24
97	60	25		4.05
98	60	30		4.86
99	60	40		6.48
100	60	25		4.05
101	63.5	19.05		3.266
102	63.5	12.7		2.177
103	63.5	25.4		4.355
104	63.5	9.525		1.633
105	70	5		0.945
106	70	6		1.134
107	70	8		1.512
108	70	12		2.268
109	70	10		1.89
110	70	15		2.835
111	70	25		4.725
112	70	30		5.67
113	70	40		7.56
114	70	3		0.567
115	70	20		3.78
116	76.2	19.05		3.919
117	76.2	25.4		5.226
118	76.2	15.875		3.266
119	76.2	38.1		7.839
120	76.2	6.35		1.306
121	76.2	12.7		2.613
122	76.2	3.175		0.653
123	76.2	4.775		
124	76.2	9.525		1.96

Standard Scaled Profiles Catalog

Flat Bar



No.	B	A	R	W/m
125	80	3		0.648
126	80	4		0.864
127	80	5		1.08
128	80	6		1.296
129	80	8		1.728
130	80	10		2.16
131	80	12		2.592
132	80	15		3.24
133	80	20		4.32
134	80	25		5.4
135	80	30		6.48
136	80	50		10.8
137	88.9	12.7		3.048
138	88.9	19.05		4.573
139	90	5		1.215
140	90	8		1.944
141	90	10		2.43
142	100	3		0.81
143	100	4		1.08
144	100	5		1.35
145	100	6		1.62
146	100	8		2.16
147	100	10		2.7
148	100	12		3.24
149	100	15		4.05
150	100	20		5.4
151	100	25		6.75
152	100	50		13.5
153	101.6	4.775		1.31
154	101.6	12.7		3.484
155	101.6	6.35		1.742

Standard Scaled Profiles Catalog

Flat Bar



No.	B	A	R	W/m
156	101.6	50.8		13.935
157	101.6	3.175		0.871
158	101.6	38.1		10.452
159	101.6	9.525		2.613
160	101.6	25.4		6.968
161	101.6	15.875		4.355
162	101.6	19.05		5.226
163	110	4	R3	1.188
164	120	4		1.296
165	120	5		1.62
166	120	6		1.944
167	120	8		2.592
168	120	9.525		3.086
169	120	10		3.24
170	120	15		4.86
171	120	20		6.48
172	120	30		9.72
173	125	40		13.5
174	125	15		5.063
175	127	6.35		2.177
176	127	9.525		3.266
177	127	12.7		4.355
178	127	25.4		8.71
179	140	15		5.67
180	150	5		2.025
181	150	6		2.43
182	150	8		3.24
183	150	10		4.05
184	150	15		6.075
185	150	20		8.1
186	150	30		12.15



Standard Scaled Profiles Catalog

Flat Bar



No.	B	A	R	W/m
187	152.4	6.35		2.613
188	152.4	9.5		3.909
189	152.4	19.05		7.839
190	152.4	25.4		10.452
191	152.4	12.7		5.226
192	160	12		5.184
193	180	20		9.72
194	200	10		5.4
195	200	15		8.1
196	200	20		10.8
197	200	8		4.32
198	203	12.7		6.961
199	203.2	6.35		3.484
200	203.2	9.525		5.226
201	204	12		6.61

Standard Scaled Profiles Catalog

Square Bar

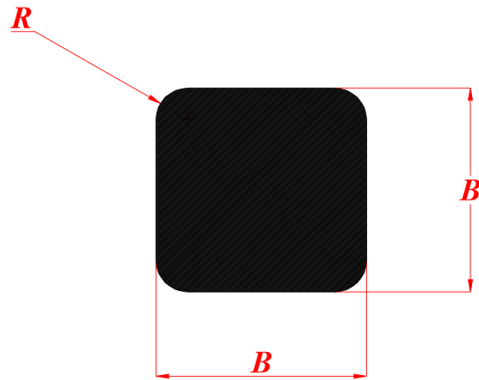

No.	B	A	R	W/m
1	10	10		0.27
2	12	12		0.389
3	12.7	12.7		0.435
4	14	14		0.529
5	15	15		0.608
6	15.875	15.875		0.68
7	16	16		0.691
8	17.145	17.145		0.794
9	18.5	18.5	23.5	0.93
10	19.05	19.05		0.98
11	20	20		1.08
12	22	22		1.307
13	22.225	22.225		1.334
14	25	25		1.688
15	25.4	25.4		1.742
16	28.575	28.575		2.205
17	30	30		2.43
18	31.75	31.75		2.722
19	34.925	34.925		3.293
20	35	35		
21	35	35		3.308
22	38.1	38.1		3.919
23	40	40		4.32
24	44.45	44.45		5.335
25	45	45		5.468
26	50	50		6.75
27	50	50	2	6.75
28	50.8	50.8		6.968
29	55	55		8.168
30	60	60		9.72
31	63.5	63.5		10.887
32	70	70		13.23



Standard Scaled Profiles Catalog

Round Bar

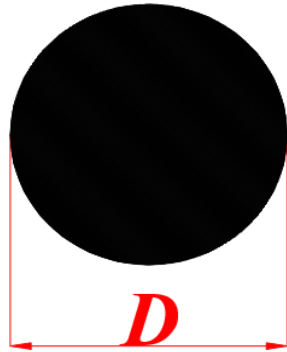

No.	D	W/m
1	9.525	0.19
2	10	0.21
3	12	0.31
4	12.7	0.34
5	15	0.48
6	16	0.54
7	18	0.69
8	19.05	0.77
9	20	0.85
10	21	0.93
11	22	1.03
12	22.225	1.05
13	25	1.32
14	28.875	
15	30	1.91
16	31.75	2.14
17	33	2.31
18	34.925	2.59
19	35	2.6
20	36	2.75
21	38.1	3.08
22	40	3.39
23	44.45	4.19
24	45	4.29
25	50	5.3
26	50.8	5.47
27	57.15	6.92
28	60	7.63
29	63.5	8.55
30	65	8.95
31	70	10.39
32	75	11.92



Standard Scaled Profiles Catalog

Equal Angle

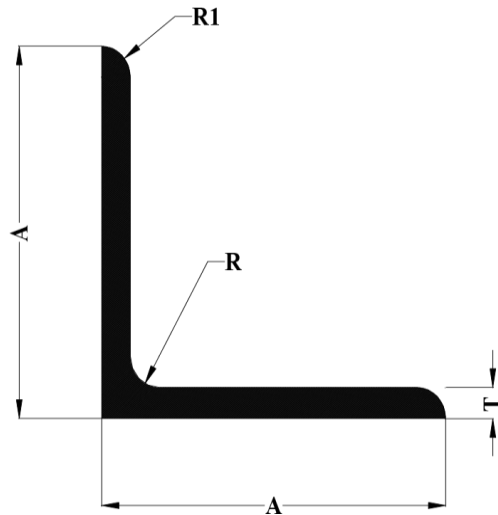

No.	A	T	R	R1	W/m
1	15	2			0.151
2	19.05	1.587			0.156
3	19.05	3.175			0.299
4	20	2			0.205
5	20	3			0.3
6	20	1.5			0.156
7	25	1.5			0.196
8	25	2			0.259
9	25	3			0.381
10	25	4			0.497
11	25.4	3.175			0.408
12	25.4	4.775			
13	25.4	1.587			0.211
14	25.4	6.35			
15	25.4	3.175	3.175	2.388	0.408
16	25.4	3.175	3.175		0.408
17	30	2			0.313
18	30	3			0.462
19	30	4			0.605
20	30	5			0.743
21	31.75	1.6			0.267
22	31.75	3.175			0.517
23	31.75	4.775			
24	31.75	3.175	3.175		0.517
25	35	2			0.367
26	35	3			0.543
27	35	4			0.713
28	35	5			0.878
29	38.1	6.35			1.198
30	38.1	4.763			0.919
31	38.1	3.175			0.626



Standard Scaled Profiles Catalog

Equal Angle

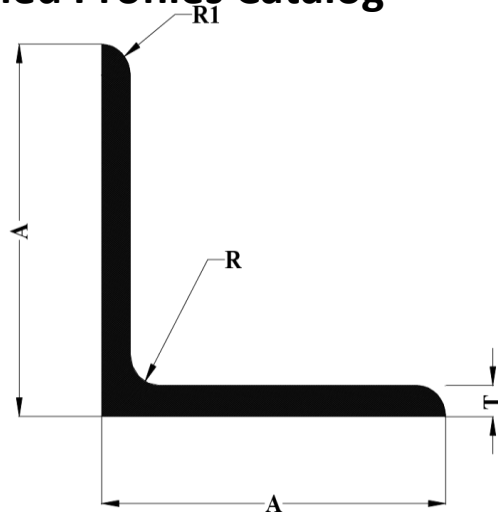

No.	A	T	R	R1	W/m
32	38.1	6.35	4.763	3.175	1.198
33	38.1	3.175	4.763	3.175	0.626
34	38.1	3.175	3.175		0.626
35	38.1	4.763	4.763		0.919
36	38.1	6.35	6.35		1.198
37	38.1	4.775	4.775		0.921
38	40	2			0.421
39	40	3			0.624
40	40	4			0.821
41	40	5			1.013
42	44.45	6.35			1.415
43	44.45	3.175			0.735
44	45	2			0.475
79	45	3			0.705
80	45	5			1.148
81	50	2			0.529
82	50	3			0.786
83	50	4			1.037
84	50	5			1.283
85	50	6			1.523
86	50	8			1.987
87	50	10			2.43
88	50	4.763	6.35	3.175	1.225
89	50.8	6.35			1.633
90	50.8	1.587			0.429
91	50.8	3.175			0.844
92	50.8	6.35			1.633
93	50.8	4.763			1.245
94	50.8	4.763			1.245
95	50.8	6.35	6.35	3.175	1.633
96	50.8	3.175	3.175		0.844



Standard Scaled Profiles Catalog

Equal Angle

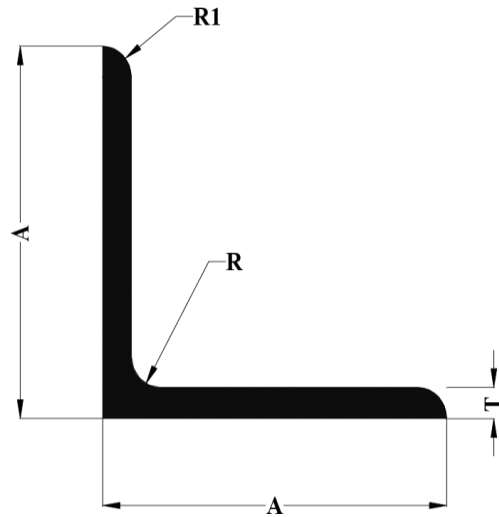

No.	A	T	R	R1	W/m
97	50.8	4.763	4.763		1.245
98	50.8	6.35	6.35		1.633
99	60	2			0.637
100	60	2.5			0.793
101	60	3			0.948
102	60	4			1.253
103	60	5			1.553
104	60	6			1.847
105	60	8			2.419
106	60	10			2.97
107	63.5	3.175			1.061
108	63.5	6.35			2.069
109	63.5	6.35	6.35		2.069
110	63.5	9.525	9.525		3.021
111	63.5	4.775			1.576
112	63.5	9.525			
113	70	2.5			0.928
114	70	6			2.171
115	70	10			3.51
116	76.2	6.35			2.504
117	76.2	4.763	4.763		1.899
118	76.2	6.35	6.35		2.504
119	76.2	9.525			
120	76.2	9.525	9.525		3.674
121	76.2	4.775	4.775		1.903
122	80	3			1.272
123	80	5			2.093
124	80	4			1.685
125	80	6			2.495
126	80	8			3.283
127	80	10			4.05



Standard Scaled Profiles Catalog

Equal Angle

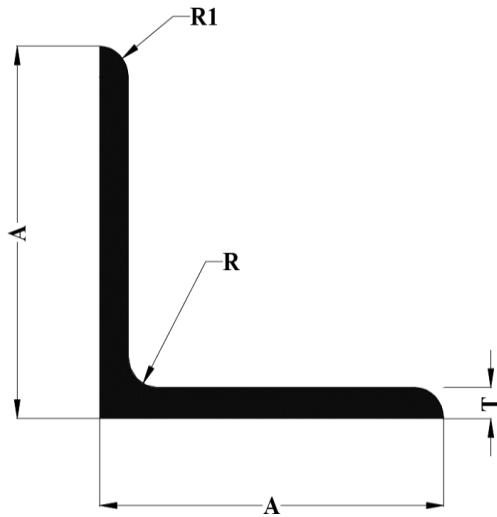

No.	A	T	R	R1	W/m
128	80	2			0.853
129	100	4			2.117
130	100	6			3.143
131	100	10			5.13
132	101.6	6.35			
133	101.6	6.35	6.35		3.375
134	101.6	9.525	9.525		4.981

Standard Scaled Profiles Catalog

U-shape

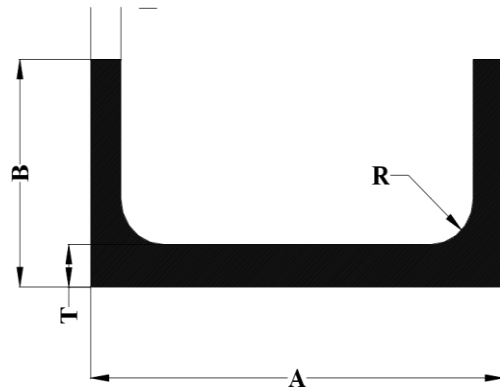

No.	A	B	T	T1	R	W/m
1	15	15	2			0.221
2	19.5	12.7	3.175			0.33
3	20	20	2			0.302
4	20	20	3			0.437
5	20	40	2.5			0.641
6	20	40	2			0.518
7	20	30	2			0.41
8	20	25	1.5			0.271
9	23	23	1.5			0.267
10	25	25	2			0.383
11	25	25	3			0.559
12	25	30	2			0.437
13	25	15	2			0.275
14	25	20	2			0.329
15	25	20	3			0.478
16	25	15	2			0.275
17	30	20	2			0.356
18	30	20	3			0.518
19	30	30	2			0.464
20	30	30	3			0.68
21	30	30	4			0.886
22	30	50	3			1.004
23	30	25	2			0.41
24	35	35	2			0.545
25	35	35	3			0.802
26	40	20	2			0.41
27	40	20	2.5			0.506
28	40	20	3			0.599
29	40	25	3			0.68
30	40	35	2			0.572
31	40	30	3			0.761

Standard Scaled Profiles Catalog

U-shape

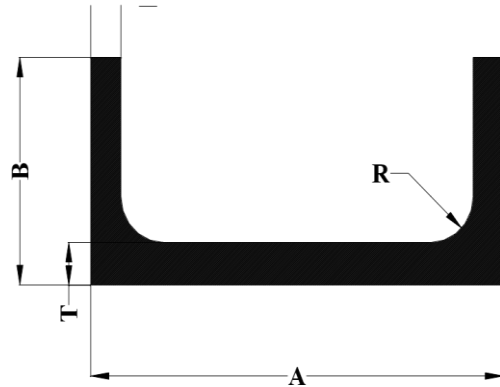

No.	A	B	T	T1	R	W/m
32	40	30	4			0.994
33	40	40	2			0.626
34	40	40	2.5			0.776
35	40	40	3			0.923
36	40	40	4			1.21
37	40	35	3			0.842
38	40	25	4			0.886
39	40	80	4			2.074
40	40	60	3			1.247
41	40	86	3			1.669
42	45	25	3			0.721
43	50	30	3			0.842
44	50	30	4			1.102
45	50	40	4			1.318
46	50	50	3			1.166
47	50	50	4			1.534
48	50	50	5			1.89
49	50	30	2			0.572
50	50.8	50.8	3.175			1.252
51	50.8	25.4	3.175	3.175	3.175	0.817
52	50.8	50.8	6.35	6.35	3.175	2.395
53	52.4	63.5	6.35	6.35		
54	60	20	2			0.518
55	60	30	3			0.923
56	60	40	2.5			0.911
57	60	40	3			1.085
58	60	40	4			1.426
59	60	40	5			1.755
60	60	60	4			1.858
61	60	60	5			2.295
62	60	30	5			1.485

Standard Scaled Profiles Catalog

U-shape

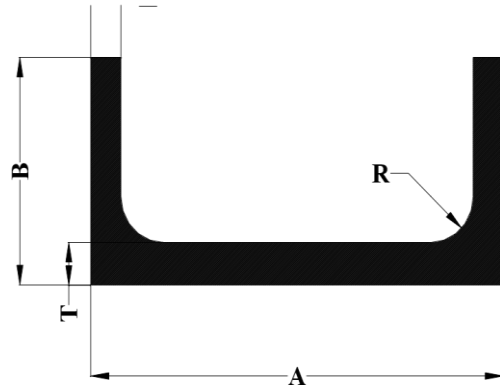

No.	A	B	T	T1	R	W/m
63	60	30	3			0.923
64	60	30	4			1.21
65	65	55	2.5			1.148
66	76.2	38.1	6.75			
67	76.2	38.1	4.75	6.35	7.925	1.833
68	76.2	50.8	6.35	7.925	7.925	2.831
69	80	30	3			1.085
70	80	40	3			1.247
71	80	40	4			1.642
72	80	40	5			2.025
73	80	45	6			2.56
74	80	50	5			2.295
75	86	40	3			1.296
76	90	50	5			2.43
77	90	50	3			1.49
78	90	50	5			2.43
79	100	50	5			2.565
80	100	50	6			3.046
81	100	64	6.4			3.719
82	101.6	50.8	6.35			3.266
83	101.6	50.8	6.35			3.266
84	101.6	50.8	6.35	7.925	9.525	3.266
85	101.6	50.8	4.763	6.35	9.525	2.491
86	120	60	5			3.105
87	120	60	5			3.105
88	120	45	10			5.13
89	125	80	8			5.81
90	125	63	6			3.872
91	127	50.8	4.763	4.75	4.75	2.817
92	127	50.8	7.137	8.712	9.525	4.13
93	127	50.8	4.78	4.78		2.827



Standard Scaled Profiles Catalog

U-shape

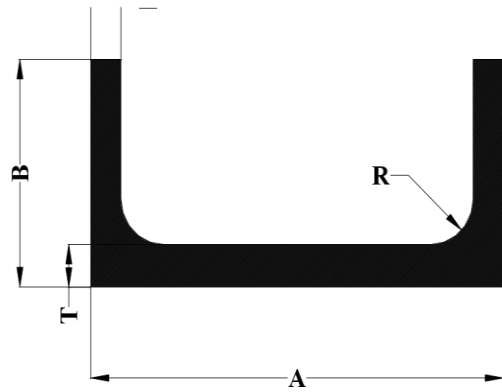

No.	A	B	T	T1	R	W/m
94	140	60	7			4.649
95	140	70	5			3.645
96	152.4	63.5	6.35	7.925	11.1	4.573
97	152.4	88.9	9.525			
98	160	80	10			8.1
99	160	80	5			4.185

Standard Scaled Profiles Catalog

Square Tube

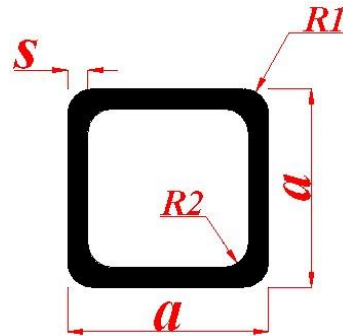

No.	a	s	R1	R2	W/m
1	19.05	1.63			0.307
2	19.05	3.048			0.527
3	20	2			0.389
4	20	3			0.551
5	20	1.5			0.3
6	24	2	2		0.475
7	25	1.5			0.381
8	25	2			0.497
9	25	3			0.713
10	25	2	2		0.497
11	25.4	3.048	3.96		0.736
12	25.4	3.75			0.877
13	25.4	1.63			0.418
14	25.4	3.048	3.96	0.91	0.736
15	25.4	2.413			0.599
16	25.4	3.048			0.736
17	25.4	3.175			0.762
18	30	1.5			0.462
19	30	2			0.605
20	30	3			0.875
21	30	4			1.123
22	30	2	2		0.605
23	30	3	3		0.875
24	31.75	3.048	6.35		0.945
25	31.75	3.25			1
26	35	2			0.713
27	35	3			1.037
28	38.1	3.175			1.198
29	38.1	3.04	3.96		1.151
30	38.1	3.17	3.96		1.196
31	38.1	3.048	3.96	1.52	1.154

Standard Scaled Profiles Catalog

Square Tube

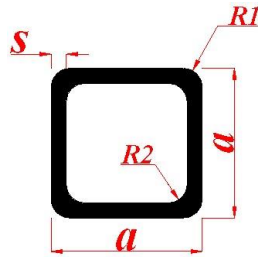

No.	a	s	R1	R2	W/m
32	38.1	3.175	3.96	0.91	1.198
33	38.1	4.775	4.78	4.78	1.719
34	38.1	3.048			1.154
35	38.1	3.175			1.198
36	40	2			0.821
37	40	2.5			1.013
38	40	3			1.199
39	40	4			1.555
40	40	4	4		1.555
41	40	1.5			0.624
42	40	2	2		0.821
43	40	2	2	0.5	0.821
44	45	2			0.929
45	50	2			1.037
46	50	2.5			1.283
47	50	3			1.523
48	50	4			1.987
49	50	5			2.43
50	50	4	4		1.987
51	50.8	6.35	9.53		3.048
52	50.8	4.78	9.53		2.376
53	50.8	3.04	9.53		1.568
54	50.8	3.25			1.669
55	50.8	6.35	9.53	3.18	3.048
56	50.8	3.048	9.53	6.48	1.572
57	50.8	4.775	9.53	4.78	2.374
58	50.8	3.175			1.633
59	50.8	4.775			2.374
60	60	2			1.253
61	60	3			1.847
62	60	4			2.419
63	63.5	3.25			2.115
64	63.5	3.048	7.11	4.06	1.99
65	63.5	4.775	6.35	6.35	3.028
66	65	2.5			1.688
67	70	2			1.469
68	70	4			2.851
69	76.2	3.9			3.045
70	76.2	6.35			4.79
71	76.2	3.048	9.53	6.48	2.408
72	76.2	4.775	4.78	4.78	3.683
73	76.2	3.048			2.408
74	76.2	4.763			3.675
75	76.2	6.35			4.79
76	80	2			1.685
77	80	3			2.495
78	80	4			3.283
79	80	4	4.5		3.283



Standard Scaled Profiles Catalog

Square Tube

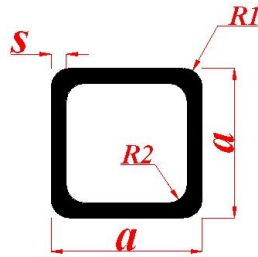

No.	a	s	R1	R2	W/m
80	80	6			4.795
81	90	4			3.715
82	100	2			2.117
83	100	3			3.143
84	100	4			4.147
85	100	4	8		4.147
86	100	5			5.13
87	101.6	4.775	9.53	4.78	4.993
88	101.6	6.35	6.35	6.35	6.532
89	101.6	4.775			4.993
90	101.6	6.35			6.532

Standard Scaled Profiles Catalog

Rectangular Tube

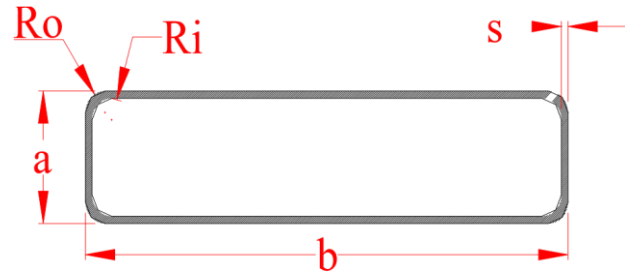

No.	b	a	s	Ro	Ri	W/m
1	25	20	2			0.443
2	30	20	2			0.497
3	30	20	3			0.713
4	30	15	1.5			0.34
5	30	15	2			0.443
6	35	20	2			0.551
7	35	25	2			0.605
8	38.1	19.05	3.175			0.871
9	38.1	19.05	1.626			0.473
10	40	15	2			0.551
11	40	20	2			0.605
12	40	20	2.5			0.743
13	40	20	3			0.875
14	40	20	4			1.123
15	40	25	2			0.659
16	40	25	3			0.956
17	40	30	2			0.713
18	40	30	2.5			0.878
19	40	30	3			1.037
20	40	30	4			1.339
21	45	25	2			0.713
22	50	15	2			0.659
23	50	20	2			0.713
24	50	20	3			1.037
25	50	20	4			1.339
26	50	25	2			0.767
27	50	25	3			1.118
28	50	30	2			0.821
29	50	30	2.5			1.013
30	50	30	3			1.199
31	50	30	4			1.555

Standard Scaled Profiles Catalog

Rectangular Tube

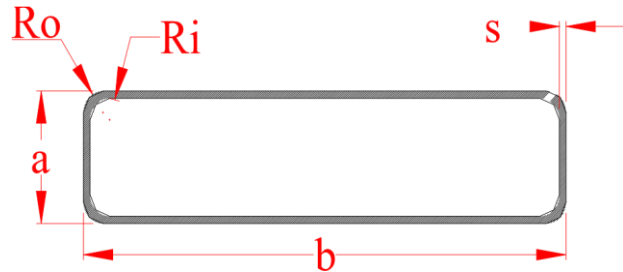

No.	b	a	s	Ro	Ri	W/m
32	50	40	2			0.929
33	50	40	2.5			1.148
34	50	40	3			1.361
35	50	40	4			1.771
36	50	25	1.2			0.47
37	50	30	1.8			0.743
38	50	25	1.5			0.583
39	50	30	2	5		0.821
40	50.8	25.4	3.25			1.223
41	50.8	25.4	3.048			1.154
42	50.8	38.1	3.175			1.415
74	76.2	50.8	6.35			3.919
75	80	20	2			1.037
76	80	30	2			1.145
77	80	30	3			1.685
78	80	40	2			1.253
79	80	40	2.5			1.553
80	80	40	3			1.847
81	80	40	4			2.419
82	80	50	2			1.361
83	80	50	3			2.009
84	80	50	4			2.635
85	80	60	3			2.171
86	80	60	4			2.851
87	80	25	2.5			1.35
88	80	20	3			1.523
89	80	50	5			3.24
90	80	40	2	2		1.253
91	80	40	3	4		1.847
92	100	18	2			1.231
93	100	20	2			1.253

Standard Scaled Profiles Catalog

Rectangular Tube

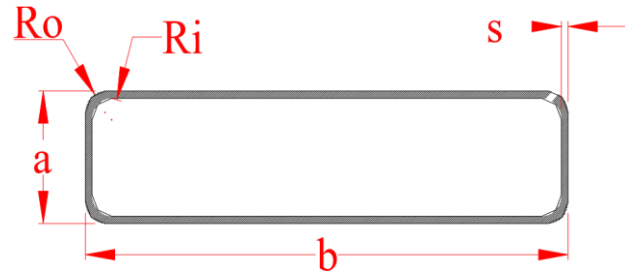

No.	b	a	s	Ro	Ri	W/m
94	100	25	2			1.307
95	100	30	2			1.361
96	100	30	3			2.009
97	100	40	2			1.469
98	100	40	3			2.171
99	100	40	4			2.851
100	100	50	2			1.577
101	100	50	3			2.333
102	100	50	4			3.067
103	100	25	1.2			0.794
104	100	60	4			3.283
105	100	18	1.8			1.112
106	100	50	6			4.471
107	100	50	5			3.78
108	100	50	2.5			1.958
109	100	60	3			2.495
110	100	20	3			1.847
111	100	80	3			2.819
112	100	50	6			4.471
113	101.6	50.8	3.048			2.408
114	101.6	50.8	6.35			4.79
115	101.6	50.8	3.175			2.504
116	101.6	70.2	6.35			5.456
117	101.6	76.2	6.35	6.4	6.4	5.661
118	101.6	25.4	3.048			1.99
119	101.6	25.4	3.25			2.115
120	101.6	50.8	3.048			2.408
121	101.6	50.8	3.175			2.504
122	101.6	50.8	4.75			3.665
123	101.6	50.8	6.35			4.79
124	101.6	76.2	6.35			5.661

Standard Scaled Profiles Catalog

Rectangular Tube

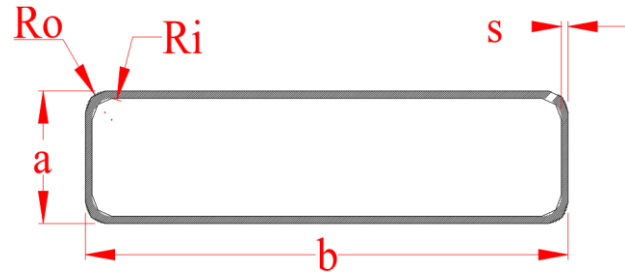

No.	b	a	s	Ro	Ri	W/m
125	120	60	3			2.819
126	120	30	3			2.333
127	120	30	2			1.577
128	120	40	4			3.283
129	120	20	2			1.469
130	120	50	4			3.499
131	120	40	2			1.685
132	120	60	4			3.715
133	127	50.8	6.35	6.4	5.2	5.661
134	127	50.8	3.175			2.94
135	130	50	4			3.715
136	140	80	4			4.579
137	140	40	4			3.715
138	150	50	4			4.147



Standard Scaled Profiles Catalog

Round Tube

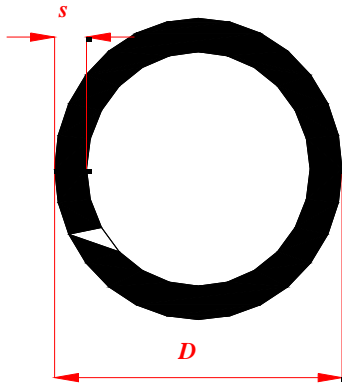

No.	D	s	W/m
1	19.05	3.125	0.422
2	20	2	0.305
3	20	2.5	0.371
4	20	3	0.432
5	20	5	0.636
6	22	2	0.339
7	22	1.5	0.261
8	22	5	0.721
9	22	3	0.483
10	24.9	1.5	0.298
11	25	2	0.39
12	25	2.5	0.477
13	25	3	0.56
14	25	5	0.848
15	25	1.5	0.299
16	25.4	1.626	0.328
17	25.4	3.251	0.61
18	28	1.5	0.337
19	28	2	0.441
20	28	2.5	0.54
21	28.575	3.125	0.674
22	30	1.5	0.362
23	30	2	0.475
24	30	2.5	0.583
25	30	3	0.687
26	30	4	0.882
27	30	5	1.06
28	31.75	3.048	0.742
29	32	1.5	0.388
30	32	2	0.509
31	32	3	0.738



Standard Scaled Profiles Catalog

Round Tube

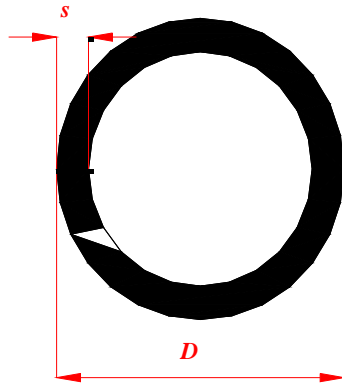

No.	D	s	W/m
32	33.4	3.378	0.86
33	33.401	3.387	0.862
34	34	2	0.543
35	35	2	0.56
36	35	2.5	0.689
37	35	3	0.814
38	35	5	1.272
39	38	1.5	0.464
40	38	3	0.89
41	38	5	1.399
42	38.1	3.175	0.94
43	40	1.5	0.49
44	40	2	0.644
45	40	2.5	0.795
46	40	3	0.941
47	40	4	1.221
48	40	5	1.484
49	42	2	0.678
50	42	3	0.992
51	42	4	1.289
52	42.164	3.556	1.164
53	44.45	3.125	1.095
54	45	2	0.729
55	45	5	1.696
56	45	2.5	0.901
57	45	3	1.068
58	48	2	0.78
59	48	2.8	1.073
60	48	3	1.145
61	48	4	1.492
62	48.26	3.683	1.392



Standard Scaled Profiles Catalog

Round Tube

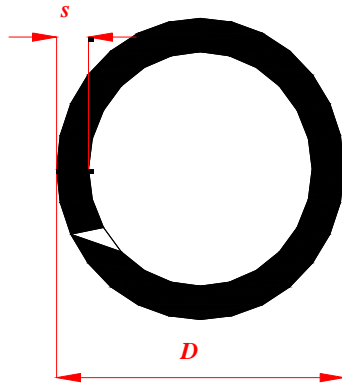

No.	D	s	W/m
63	48.41	4.47	1.665
64	50	1.5	0.617
65	50	2	0.814
66	50	2.5	1.007
67	50	3	1.195
68	50	4	1.56
69	50	5	1.908
70	50	10	3.391
71	50	6	2.238
72	50.8	3.175	1.282
73	50.8	3.251	1.311
74	50.8	6.35	2.393
75	51	2	0.831
76	55	2	0.899
77	60	10	4.239
78	60	2	0.983
79	60	2.5	1.219
80	60	3	1.45
81	60	4	1.899
82	60	5	2.331
83	60.325	3.912	1.871
84	60.325	5.537	2.572
85	60.325	5.537	2.572
86	60.33	3.91	1.87
87	60.33	5.53	2.569
88	69.85	1.626	0.94
89	70	2	1.153
90	70	3	1.704
91	70	4	2.238
92	70	5	2.755
93	70	1.5	0.871



Standard Scaled Profiles Catalog

Round Tube

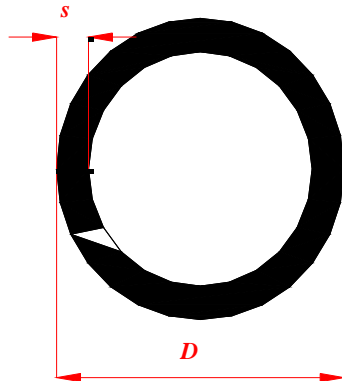

No.	D	s	W/m
94	73.025	7.01	3.923
95	73.3	7.013	3.941
96	75	5	2.967
97	75	2	1.238
98	76	3	1.857
99	76.2	1.626	1.028
100	76.2	6.35	3.76
101	76.2	3.175	1.966
102	76.2	6.35	3.76
103	80	2	1.323
104	80	3	1.958
105	80	4	2.577
106	80	5	3.179
107	80	10	5.935
108	90	2	1.492
109	90	3	2.213
110	90	5	3.603
111	100	2	1.662
112	100	3	2.467
113	100	4	3.256
114	100	5	4.027
115	101.6	3.175	2.649
116	101.6	8.077	6.404
117	106	3	2.62
118	108	3	2.671
119	110	5	4.451
120	114.3	6.02	5.526
121	120	5	4.875
122	125	5	5.087
123	130	5	5.299
124	139.7	12.7	13.674



Standard Scaled Profiles Catalog

Round Tube

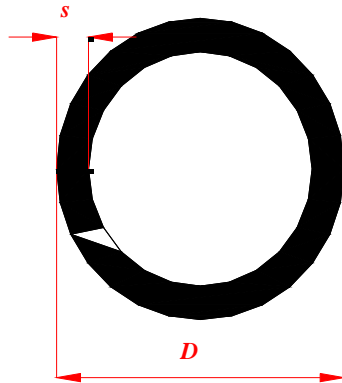

No.	D	s	W/m
125	140	5	5.723
126	150	5	6.147
127	152.4	3.175	4.017



Standard Scaled Profiles Catalog

T-Shape

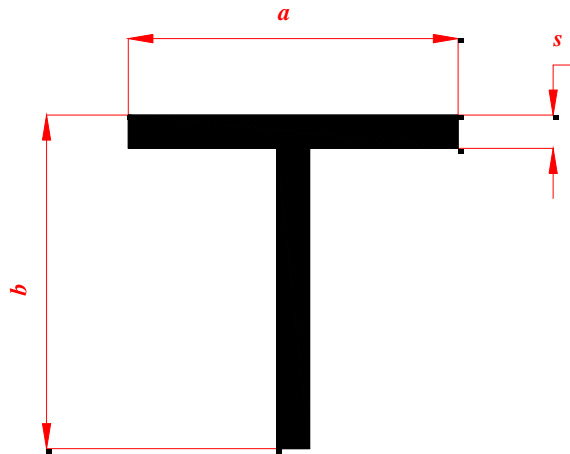

No.	a	b	s	W/m
1	25	25	3	0.381
2	30	30	3	0.462
3	35	35	3	0.543
4	40	25	2	0.34
5	40	40	3	0.624
6	40	40	4	0.821
7	45	45	4	0.929
8	50	50	3	0.786
9	50	50	4	1.037
10	50	50	5	1.283
11	60	60	4	1.253
12	60	60	6	1.847
13	80	80	8	3.283



Standard Scaled Profiles Catalog

Z-Shape

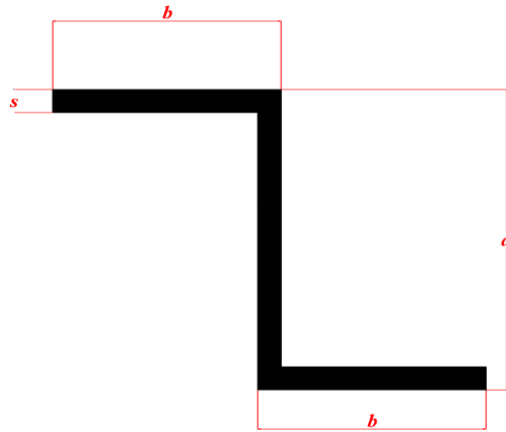

No.	a	b	t	W/m
1	15	40	2	0.491
2	25	25	3	0.559
3	40	15	2	0.356



Standard Scaled Profiles Catalog

I-Shape

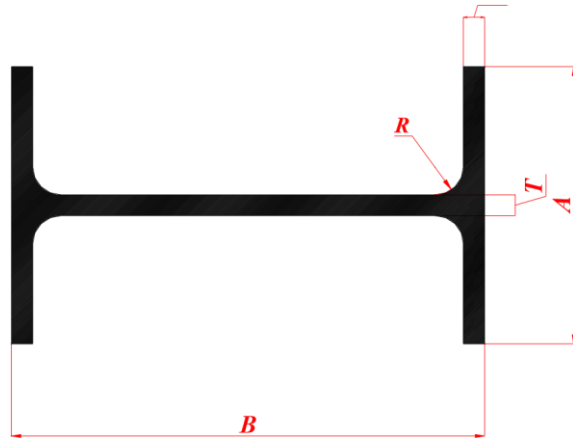

No.	b mm	amm	Tmm	TR	Rmm	W/m
1	101.6	76.2	4.763	4.763	6.35	3.24
2	127	76.2	5.715	5.715	7.595	4.23
3	76.2	63.5	6.35	6.35	9.525	3



Standard Scaled Profiles Catalog

U-Shape

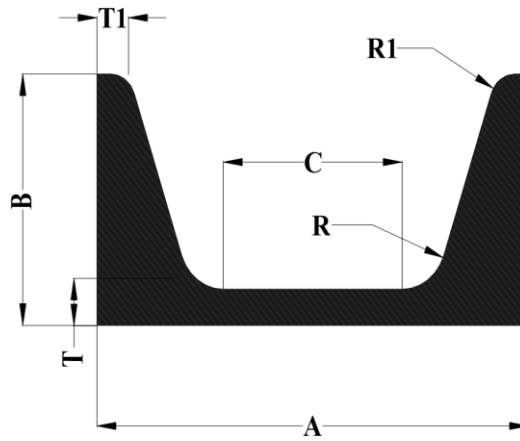

A	B	C	T	T1	R	R1	W/m
152.4	51.664	114.3	7.976	5.08	7.62	3.048	5.447



SCAN *Me*

Km28 Cairo Alex desert road
Abu Rawash Industrial zone,
Cairo, Egypt.

For Sales : +20 114 322 8877
+20 100 7750 490
+20 111 117 6662

For Powder coating (AluPro):
+20 110 0221205
For following and suggestions:
+20 111 5051265

sales@aluafric.com.eg
info@aluafric.com.eg